

**Stackable**

**MATERIALS & FEATURES**

- 1 bicycle secured - long-term parking solution (**Class 1**)
- ASTM A36 High Security Steel Walls
- ASTM A53 Steel Pipe Handle
- Dual Locking Point Doors
- Stackable For Increased Parking Density
- Optional Stainless Trident Security Nut (**Upgrade**)

**FINISH OPTIONS**

- UV Resistant Metallic Grey Powder Coat

**MOUNTING OPTIONS**

- Surface mount - Concrete (**Anchors Sold Separately**)
- Surface mount - Asphalt/Pavers (**Anchors Sold Separately**)

**SPACE USE RECOMMENDATIONS**

- Front of locker to wall setback (door swing clearance)
  - Minimum: 48"
  - Recommended: 60"
- Parallel to a wall
  - Less than 3" or more than 9"\*\*
- Distance between lockers
  - Less than 3" or more than 9"\*\*

\*\*Child safety requirements

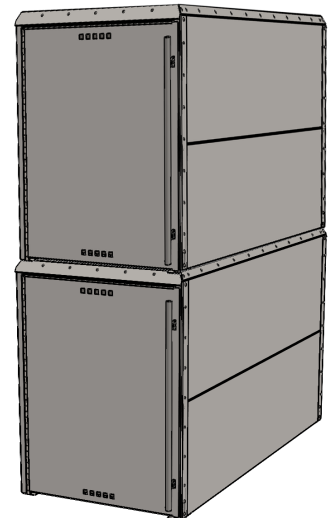
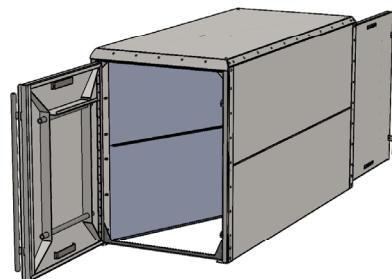
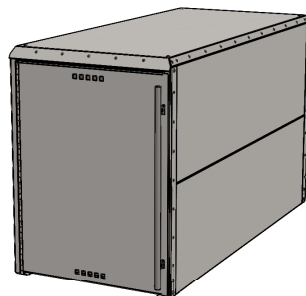
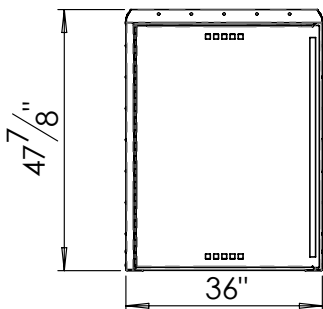
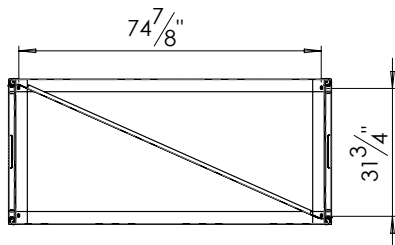
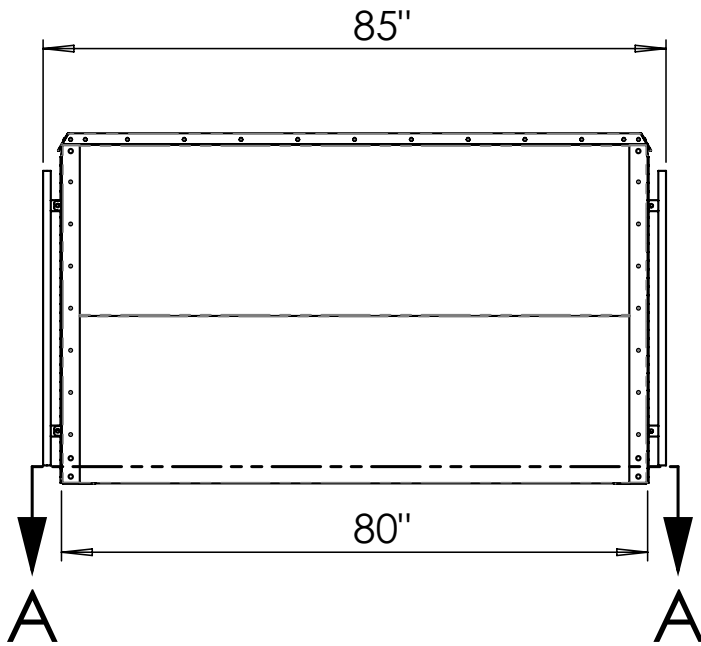
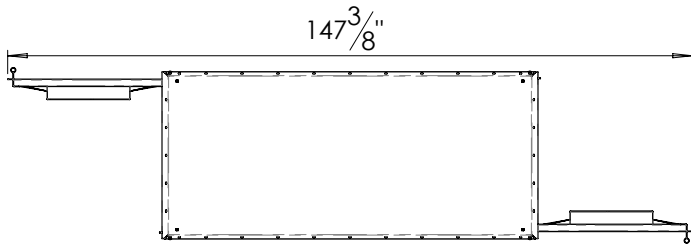

**Stackable**

**MATERIALS & FEATURES**

- 2 bicycle secured - long-term parking solution (**Class 1**)
- ASTM A36 High Security Steel Walls
- ASTM A53 Steel Pipe Handle
- Dual Locking Point Doors
- Stackable For Increased Parking Density
- Optional Stainless Trident Security Nut (**Upgrade**)

**FINISH OPTIONS**

- UV Resistant Metallic Grey Powder Coat

**MOUNTING OPTIONS**

- Surface mount - Concrete (**Anchors Sold Separately**)
- Surface mount - Asphalt/Pavers (**Anchors Sold Separately**)

**SPACE USE RECOMMENDATIONS**

- Front of locker to wall setback (door swing clearance)
  - Minimum: 48"
  - Recommended: 60"
- Parallel to a wall
  - Less than 3" or more than 9"
- Distance between lockers
  - Less than 3" or more than 9"

\*\*Child safety requirements